

# Saramonic

**2.4GHz Wireless Smart Microphone  
with Touchscreen**

2.4GHz

**BlinkMe**

User Manual

## Statement

Please read this manual carefully before using and strictly operate and store it in accordance with the instructions. Please save the manual for your future reference. If you need further assistance than the user manual, please consult your retailer for help or email us: [info@saramonic.com](mailto:info@saramonic.com)

- Non-professional teardown is strictly prohibited.
- Please keep it away from heat sources such as heaters or ovens.
- Do not remove the battery without professionals' help.
- Please clean the device with only a soft, dry cloth.
- When using and storing, please keep away from the dust and moisture.

## General Introduction

The Saramonic BlinkMe, a professional dual channel wireless microphone system with touchscreen, which can be used with different magnetic accessories. This ultra-portable and incredibly lightweight mic system boasts universal compatibility with tablets, laptops, cameras, recorders, mixers, and other audio/ video recording devices. Ideal for content creators, filmmakers, journalists, vloggers, live streaming, and so much more.

- Quick and easy to operate the intuitive touchscreen
- Separate OS without having to rely on any application
- Smart onboard recording capability
- Also available in 48kHz HD audio when noise reduction enabled
- The receiver can charge the transmitter(s)
- Customize the wallpaper for the transmitter through the Saramonic App
- A magnetic system with several accessories
- Flexibly attach or remove the transmitter to or from clothes

# Overview

## Transmitter

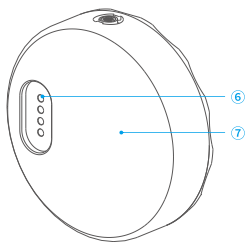
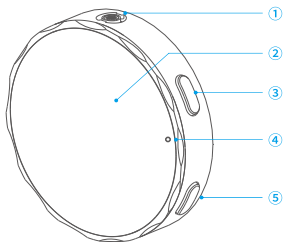

### ① Microphone Capsule

### ② Touchscreen

### ③ Power Button

- Press and hold for 3 seconds power on or off.
- Press twice to lock or unlock the screen.

### ④ LED Indicator

Indicates the status of the transmitter when its screen is turned off.

Indicator	Status
Blinking blue slowly	Unpaired
Blinking blue quickly	Pairing
Static blue	Paired successfully
Blinking red slowly	Mute
Blinking red quickly	Low battery
Static red	Charging
Red light off	Fully charged

### ⑤ NR Button

- Press to enable or disable noise reduction.
- Press twice to enable or disable onboard recording.
- Press and hold for 1.5 seconds to mute or unmute the microphone.

### ⑥ Contacts

### ⑦ Magnet

## Receiver

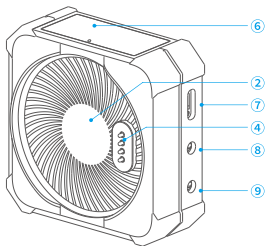
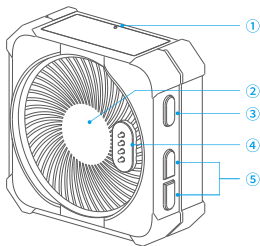

### ① LED Indicator

Indicates the status of the receiver when its screen is turned off.

Indicator	Status
Blinking blue slowly	Unpaired
Blinking blue quickly	Pairing
Static blue	Paired successfully
Blinking red quickly	Low battery
Static red	Charging
Red light off	Fully charged

### ② Magnet

### ③ Power Button

- Press and hold for 3 seconds power on or off.
- Press twice to lock or unlock the screen.

### ④ Contacts

### ⑤ +/- Button

Press to turn up or turn down the output gain level of the receiver in 3dB increments from -12dB to +12dB.

### ⑥ Touchscreen

### ⑦ USB-C Port

Used for charging the receiver and transferring data.

### ⑧ 3.5mm Monitor Port

Connect your headphone to monitor the audio output.

### ⑨ 3.5mm Auto-Sensing Output (TRS/TRRS)







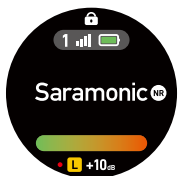



For analog audio output to a camera, smartphone or mixer, etc.

# Touchscreen Operations

















## Transmitter











- From the Home screen, press the power button to turn the screen on or off.
- To return to the Home page from any other pages, press the power button once.
- Press the power button twice to lock or unlock the screen and return to the Home page.

	Indicates the screen is locked or unlocked. 💡 It is recommended that you can lock your screen to avoid accidental taps during a recording. By default, the device returns to the Home screen automatically when the screen is locked.
	Indicates the current wireless signal strength between transmitter 1 and the receiver. A gray icon indicates a failed connection.
	Indicates the battery level of the transmitter.
	Indicates the noise reduction is enabled.
	Indicates the audio input level. 💡 Reduce the transmitter gain accordingly when the volume bar turns red.
	Indicates the microphone is muted.
	Indicates the onboard recording is enabled.
	Indicates the input gain of the transmitter.
	Indicates the left or right sound channel.
	Indicates Stereo, Mono or Safety Channel mode.

From the Home screen, swipe up from the bottom of the screen to access device settings. Swipe up or down to select Onboard Recording, Noise Reduction, TX Gain, Brightness, Display and Settings. From device settings, tap  to return to the previous screen.

	 REC Protection	When the function is activated, the onboard recording can only be disabled by operating the screen instead of pressing the button.
	 Auto Recording	When the function is activated, the onboard recording will be enabled automatically as soon as the transmitter is switched on.
	 Bit Depth	Tap to set bit depth to 16bit or 24bit.
	<input type="radio"/> Original sound	Default to original sound. Select original sound or HD noise reduction on demand.
	<input type="radio"/> HD noise reduction	
		Drag the Gain control slider to adjust the input gain level of the transmitter in 1dB increment from -12dB to +12dB. Note that the transmitter gain will affect the volume of the recorded audio.
		Drag the Brightness slider to adjust the screen brightness.
	<input type="radio"/> Power saving	By default, when enabled, this will turn screen brightness to 50% and turn the screen off after 10 seconds of inactivity.
	<input type="radio"/> Always on	When enabled, the screen will always stay on.
	<input type="radio"/> Auto screen off	Scroll up or down to set the time when the screen is turned off automatically.
	 Pairing	Tap to access the page where you can pair the transmitter with the receiver.
	 Language	Tap to choose a language.
	 Date & Time	Tap to set the date and time for the recording files.
	 Reset	Tap to restore the transmitter to its factory default settings, which resets everything except the onboard recording files and current pairing status.
	 Version	Tap to view the firmware version and serial number of the transmitter.
	 Cert info	Tap to view certification information.

From the Home screen, swipe down from the top of the screen to display Quick settings.

 Power saving	Tap to switch.
 Always on	
 Auto screen off	
 Microphone muted	Tap to switch.
 Microphone unmuted	
 Onboard recording enabled	Tap to switch.
 Onboard recording disabled	
 Settings	Tap to quickly access.

## Themes

Choose a theme you want to be applied to your Home screen.

1. From the Home screen, touch and hold the screen.
2. Swipe up or down to view nine types of default themes.
3. Tap the screen to apply the selected theme.







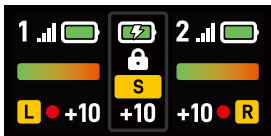



If you want, you also can customize the wallpaper for your Home screen on the Saramonic app. To download the app, scan the QR code on the screen.

## Receiver





















- To return to the Home page from any other pages, press the power button once.
- Press the power button twice to lock or unlock the screen and return to the Home page.







	<p>Indicates the screen of the receiver is locked or unlocked. 💡 It is recommended that you can lock your screen to avoid accidental taps during a recording. By default, the device returns to the Home screen automatically when the screen is locked.</p>
	<p>Left and right sides: The transmitter's battery level. Middle of the screen: The receiver's battery level.</p>
	<p>Indicates that the receiver is charging.</p>
	<p>Indicates that the transmitter is being charged by the receiver.</p>
	<p>Indicates that the receiver is in Mono, Stereo, or Safety Channel mode.</p>
<p>+10</p>	<p>Left and right sides: The transmitter's input gain. Middle of the screen: The receiver's output gain.</p>
<p>1 .lll</p>	<p>Indicates the wireless signal strength between transmitter 1 and the receiver.</p>
<p>2 .lll</p>	<p>Indicates the wireless signal strength between transmitter 2 and the receiver. If there's no second transmitter connected, this icon will not be displayed.</p>
	<p>Indicates the audio input level. 💡 Reduce the transmitter gain accordingly when the volume bar turns red.</p>
<p>L R</p>	<p>Indicates the left or right sound channel. 💡 Under Stereo mode, transmitter TX1 matches the left channel, transmitter TX2 matches the right channel.</p>
	<p>Indicates the onboard recording is enabled.</p>
	<p>Indicates the microphone is muted.</p>



From the Home screen, swipe down from the top of the screen to access device settings. Swipe left or right to select Recording Mode, RX Gain, TX Gain, Display and Settings. From device settings, swipe up from the bottom of the screen to return to the previous screen.

	 Mono	Signal from the transmitter or both transmitters can be mixed together and recorded identically to left and right channels.
	 Stereo	Signals from each transmitter can be recorded to a separate channel.
	 Safety Channel	Similar to Mono mode, the audio of the right channel will be recorded in -6dB in case distortion in your recordings.
		Drag the Gain control slider to adjust the output gain level of the receiver in 1dB increment from -12dB to +12dB. The receiver gain can be reduced if the sound is distorted.
		In the paired state, tap left or right to set TX1 or TX2. Drag the Gain control slider to adjust the input gain level of the transmitter(s) in 1dB increment from -12dB to +12dB. Note that the transmitter gain will affect the volume of the recorded audio.
	 Power saving	By default, when enabled, this will turn screen brightness to 50% and turn the screen off after 10 seconds of inactivity.
	 Always on	When enabled, the screen will always stay on.
	 Pairing	Tap to pair the receiver with the transmitter(s).
	 Brightness	Tap it, then drag the Brightness slider to adjust the screen brightness.
	 Language	Tap it, then swipe left or right to choose a language.
	 Reset	Tap to restore the receiver to its factory default settings, which resets everything except the current pairing status.
	 Version	Tap to view the firmware version and serial number of the receiver.
	 Cert info	Tap to view certification information.

To access transmitter TX1 or TX2 settings from the Home screen, swipe up on the left or right side of the screen.

 Onboard recording enabled	Tap to switch.
 Onboard recording disabled	
 Microphone muted	Tap to switch.
 Microphone unmuted	
 Memory	Indicates the remaining available time for recording. Tap to access a submenu.
 Format	Tap to erase the onboard recording files of the transmitter.

## Using BlinkMe

### Transmitter

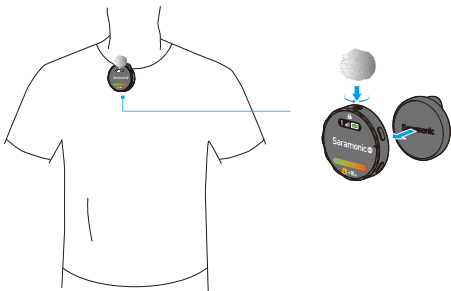

Use the magnetic clip to attach the transmitter to clothes.

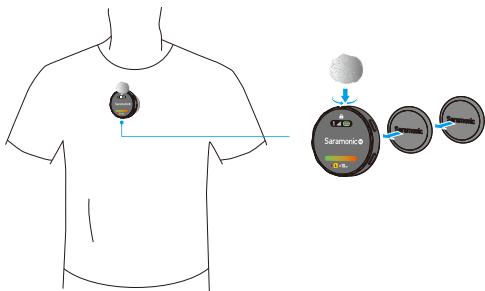

Use the magnets to attach the transmitter to clothes.

## Receiver

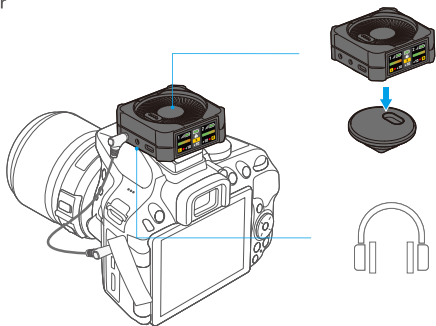

1. Connect a camera, a smartphone or a laptop to the 3.5mm auto-sensing audio output of the receiver with an adapter cable.
2. Plug your headphones for audio monitoring as your need.

 If the camera you used was SONY ZV-1, ZV-1 II, or ILCE-7C, please mount the included ZV-1 adapter on your camera first.

## How to Pair

The transmitter and receiver are paired by default. If they are disconnected, please tap the screens of the transmitter and receiver to enter Settings, and then tap "Pair" to reconnect.

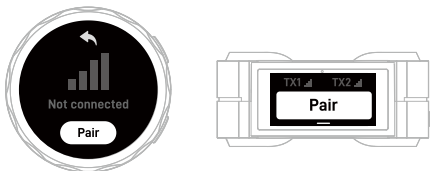

1. When both TX1 and TX2 need to be paired with RX, operate the transmitter first, and then operate the receiver.
2. If the screen of a device is failed to operate, press and hold the power button for 18 seconds to force the shutdown of the device, and then press and hold the power button for 3 seconds to turn the device on.
3. Due to the 2.4GHz wireless frequency is widely used, the signal may be easily attenuated or interfered. Please try to avoid obstacles while using, such as walls and buildings. And keep away from the devices with 2.4GHz frequency, such as high-power Wi-Fi antennas, radios, etc.

## How to Charge

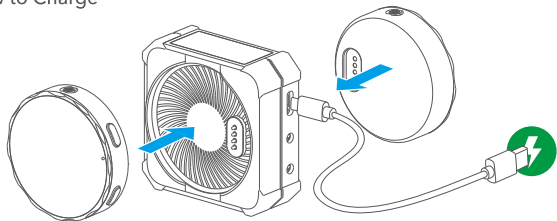

1. To charge the transmitter(s), please place it(them) on the receiver.  
If the receiver reaches its safe battery level, it will stop charging the transmitter(s).
2. Use the included USB-A to USB-C cable to charge the receiver when the battery is low.

## Audio Output for Dual Devices

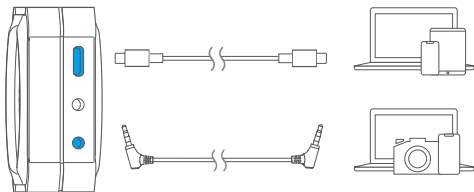

To output audio simultaneously, connect the receiver to two devices via the 3.5mm auto-sensing output or USB-C output using a correct cable.

## Onboard Recording

- The memory can store up to 22 hours of recording at the 48kHz/16bit sampling rate. The memory can store up to 15 hours of recording at the 48kHz/24bit sampling rate.
- The file will be automatically split after 30 minutes of recording, making it easy to quickly find your desired recording segment.
- By default, the recording files are named in the format "DATE-TIME.WAV". Up to 999 recording files can be created.
- If the memory is full, the original file will be automatically overwritten with the latest file from the beginning.

💡 Note that in this mode, the "mute" function will not affect the onboard recording.

## Loading Files

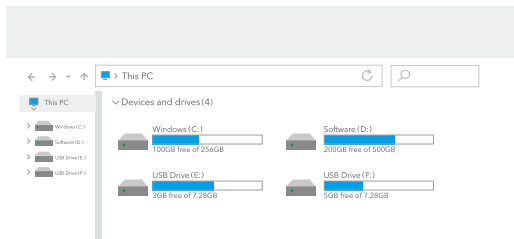
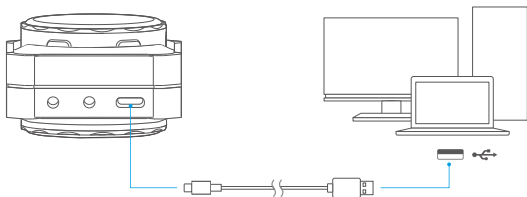

Place the transmitters on the receiver, and then connect a laptop to the receiver's USB-C port to read the recording files of TX1 and TX2.(You can rename the device in the Saramonic app.)

## Specifications

Display	TFT
Transmission Type	2.4GHz digital frequency
Modulation	Digital modulation
Polar Pattern	Omnidirectional
Antenna	In-built antenna
Operating Range (without obstacles)	328' (100m)
RF Output Power	< 10mW
Sampling Rate	48KHz
Frequency Response	20Hz-20KHz
Signal-to-Noise Ratio	>80dB
Maximum SPL	110dB SPL
Sensitivity	-39±2dB
Audio Input Connector	TX: In-built condenser microphone
Monitoring Connector	RX: 3.5mm monitor port
Audio Output Connector	RX: 3.5mm auto-sensing output (TRS/TRRS)
Power Requirements	In-built rechargeable lithium-ion battery
Battery Specification	TX: 3.85V/495mAh RX: 3.7V/1600mAh
Charging Connector	TX: Charging contacts RX: USB-C
Charging Time	RX: Approx. 2.5 hours (using 5V/2A charger)
Battery Life	TX: Approx. 5 hours (onboard recording enabled) Approx. 8 hours (onboard recording disabled) RX: Approx. 24 hours (One TX fully charged)
Memory	TX: 8GB
Weight	TX: 1.06oz (30g) RX: 2.47oz (70g)
Dimensions	TX: $\varnothing 1.85 \times 0.49''$ ( $\varnothing 47 \times 12.5\text{mm}$ ) RX: $2.23 \times 2.23 \times 0.99''$ ( $56.6 \times 56.6 \times 25.2\text{mm}$ )
Operating Temperature	0°C to +50°C
Storage Temperature	-10°C to +50°C

## Troubleshooting

If you encounter problems when using the unit, please refer to the following checklist before contacting technical support. If the problem cannot be solved, please contact the dealer's after-sales service department.

- **If there is no sound from the unit or no sound when connected to an external device**
  - ① Make sure that the connecting cable between the product and the device is not loose.
  - ② Make sure the gain and volume are not turned to minimum.
  - ③ Make sure the transmitter is not muted.
- **If sound of the unit is too low or too loud or even distorted**

Adjust mic gain and volume to the suitable level for recording in the current environment to improve the recording effect.
- **Current noise or other abnormal noise appears during monitoring**
  - ① Replace the connecting cable.
  - ② Make sure there is no interference near the unit. If the noise still exists after changing the unit's position, please contact our customer service.
- **Failed to communicate with the other party when using applications such as live stream, conference, or communication (the other party's voice cannot be heard via the 3.5mm monitor port)**

Make sure to connect your device to the receiver's USB-C port. The receiver's 3.5mm output port can only output audio but cannot communicate with the other party.
- **The operating range of the unit is limited and the sound is intermittent frequently**

Make sure there is no interference between the transmitter and receiver. If the intermittent sound still occurs frequently, please contact our customer service.
- **If the transmitter or receiver suddenly freezes up**

Press and hold the power button of the transmitter or receiver for 18 seconds to force the shutdown.



## Other Accessories

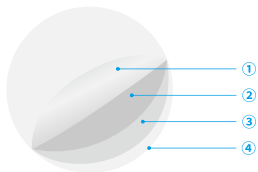

Screen Protector for Transmitter



Screen Protector for Receiver

- ① Remove it
- ② Clear the dust on the screen
- ③ Stick on the screen protector
- ④ Release liner

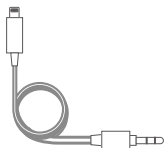

3.5mm TRS Male to Lightning Audio Cable (SR-C2000)

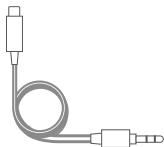

3.5mm TRS Male to USB-C Audio Cable (SR-C2001)

## Contents of BlinkMe B2



2×  
Transmitter



1×  
Receiver



2×  
Magnetic Clip



2× Fur  
Windshield



4×  
Magnet



1× 1/4" Magnetic  
Cold Shoe Adapter

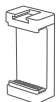

1× MVC  
Phone Holder

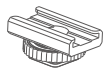

1× ZV-1  
Adapter



1× 3.5mm TRS  
Male to Lightning  
Audio Cable



1× 3.5mm TRS  
Male to USB-C  
Audio Cable



1× 3.5mm TRRS  
to 3.5mm TRRS  
Audio Cable



1× 3.5mm TRS  
to 3.5mm TRS  
Audio Cable



1× USB-A to  
USB-C  
Cable



2× Screen  
Protector  
for Transmitter



1× Screen  
Protector  
for Receiver